

version .0

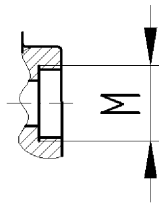
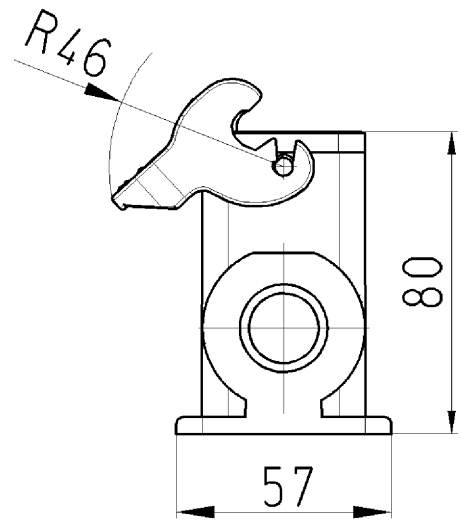
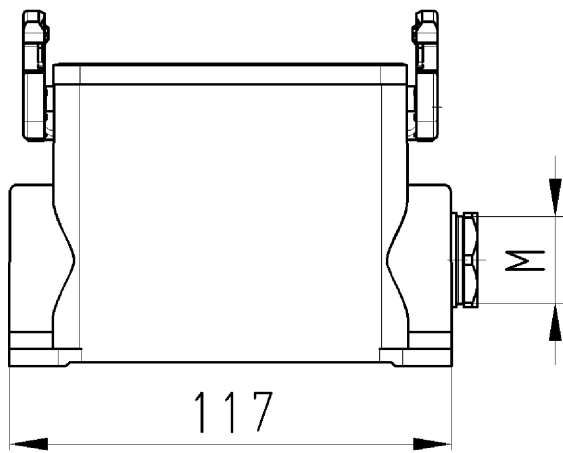

version .1

Gehäuseunterteil  
76.331.4035.0

Zeichnungsnummer  
76.331.4035.010W  
Gehäuseunterteil

04.01.2008  
Hoffmann Angelika  
M 1:2